



art metal

08 PHENIX

F.P.H. Art Metal Sp.j.

Ul. Jabłoniowa 124, 83-331 Łapino Kartuskie, Poland
 Tel. 0048 58 681 80 78, Fax: 0048 58 681 80 64
 www.art-metal.pl e-mail: biuro@art-metal.pl

Construction:

The unit includes a lamp body (1) with a tray (2). An igniter module (3) and a lampholder (4) are mounted on a lamp base (2). The lampholder accepts a lamp (5). The tray (2) and the lamp (5) are covered by a reflector (ODB-7) (6). All the fittings are contained inside a shade (7) fixed to the lamp body (1) covered from the top with a decorative cup (8). Tight connection between the shade (7) and the lamp body (1) and the cup (8) assured by gaskets (9).

Mounting instructions:

- Position the lamp body (1) on a pole or arm, and tighten the mounting bolts.
- Lead out the electrical cables and connect them to the terminals of the igniter module (3).
- *) -Attach the lamp base (2) to the lamp body (1).
- Put the lamp (5) in position.
- Attach the reflectors (6).
- *) -Fix the gasket (9) and the shade (7) in position.
- Attach the decorative cap (8) and secure it with the mounting bolts.

If any lantern elements are supplied factory-mounted, the mounting stages marked with *) should be omitted (as this has already been done by the manufacturer)

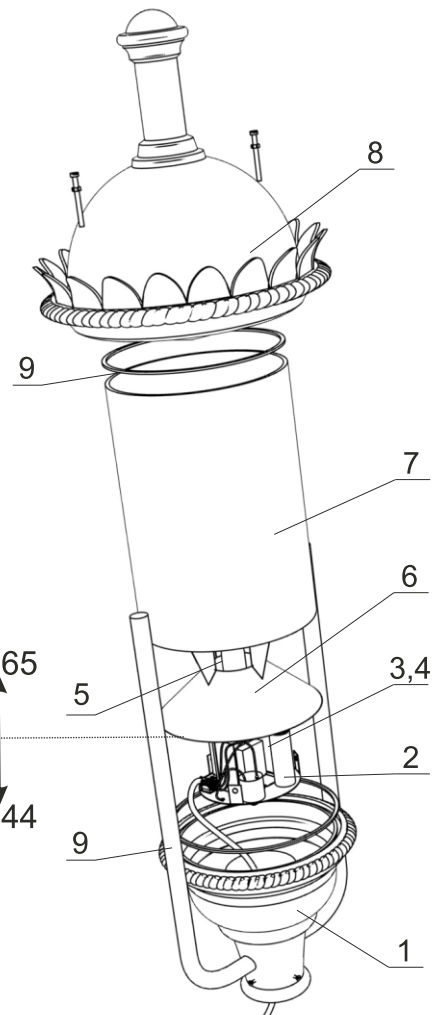

IP 65

IP 44

TECHNICAL DATA:

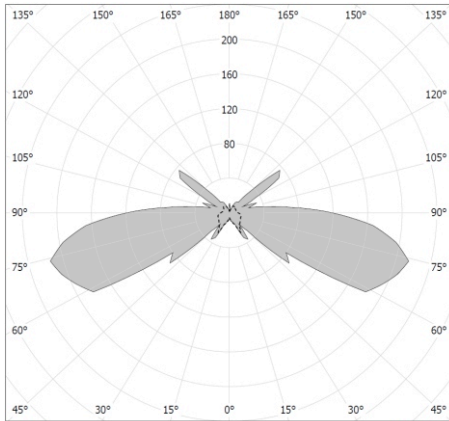

Photometry (polar plot)

Power: ~230/50Hz

Protective class: I

IP44 -electrical part

IP65 -optical part

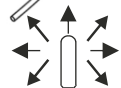
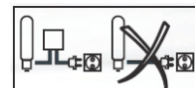

ELECTRICAL DIAGRAM:

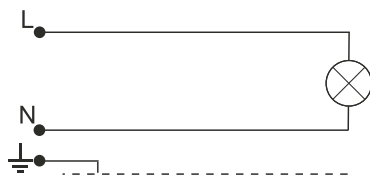

1. Incandescent bulb

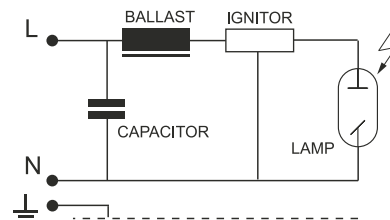

2. Sodium / metal halide lamps

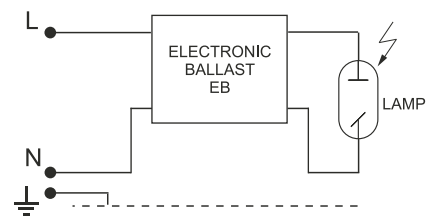

3. Sodium / metal halide lamps

Type	Light-producing element	Lamp holder	Weight [kg]	Pn [W]		Luminary dimensions
				IC	EB	
08MH-70W	MH/HSI/HPI	E27	13,7	81	75	
08MH-100W	MH/HSI/HPI	E27	14,2	114	105	
08MH-150W	MH/HSI/HPI	E27	14,9	169	155	
08S-70W	WLS/SHP/SON	E27	13,7	81	75	
08S-100W	WLS/SHP/SON	E40	14,3	114	105	
08S-150W	WLS/SHP/SON	E40	15,0	169	155	
08Z-E/Z	Bulb / MINI - LINX	E27	12,2	Maks. 60		

WARNING !! The weight of the unit may slightly differ for individual production batches.

Sign:L-0008-01-04

Last revision: 2016.01.27

